

Generation 360

SPECIFICATIONS & MAXIMUM CAPACITIES

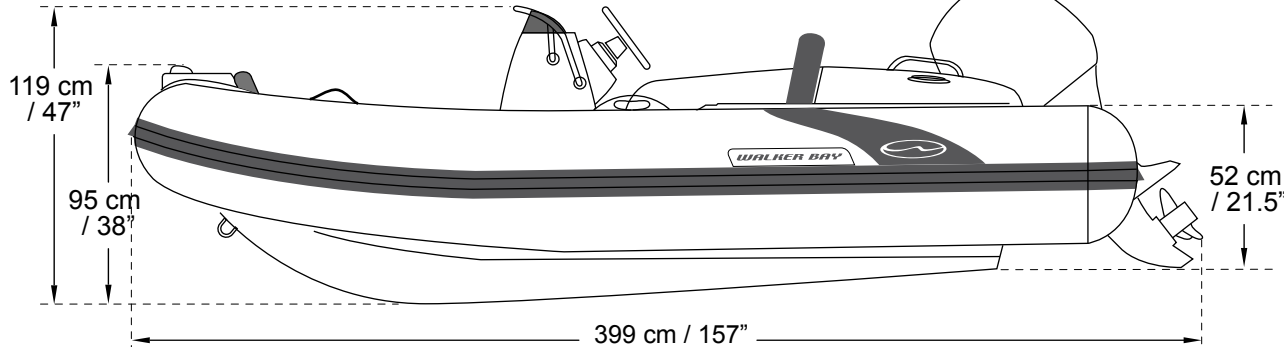

WALKER BAY



Side View

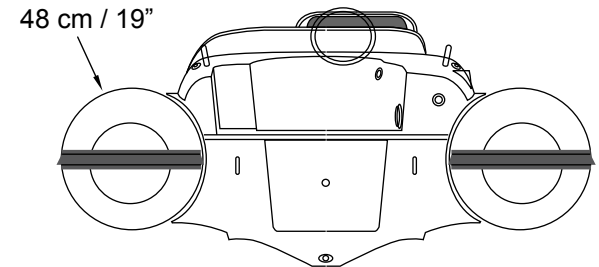

Rear View

Top View

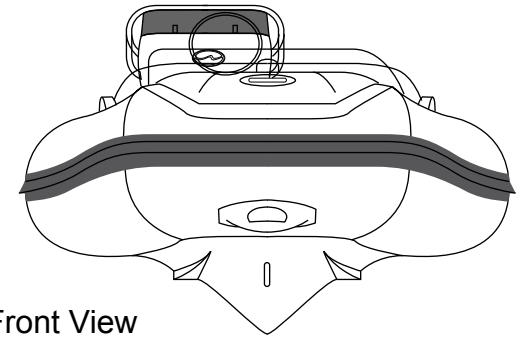
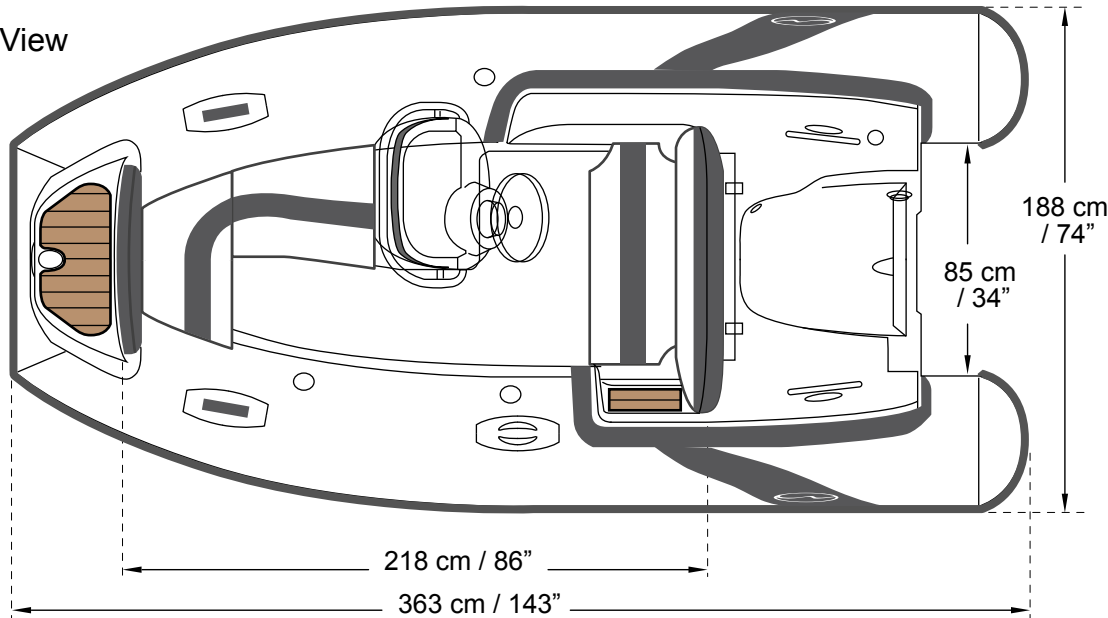

Front View

SPECIFICATIONS AND MAXIMUM CAPACITIES (Subject to change without notice. Tolerances: Dimensions +/- 3% Weight +/- 5%)

MODEL	ISO 6185 PART	ISO 6185																Wet Weight (Approximate) 40HP (30kW) + Fuel		AIR CHAMBERS				
			KG	LB	#	KG	LB	Length	KG	LB	Maximum		Recommended		Maximum Speed			KG	LB		KG	LB	PSI	BAR
												KW	HP	KW	HP	KT	MPH	Km/h						
Generation 360	3	C	599	1317	5	375	825	L	99	252	30	40	30	40	30	34	55	220	487	356	783	3	3.5	0.24